

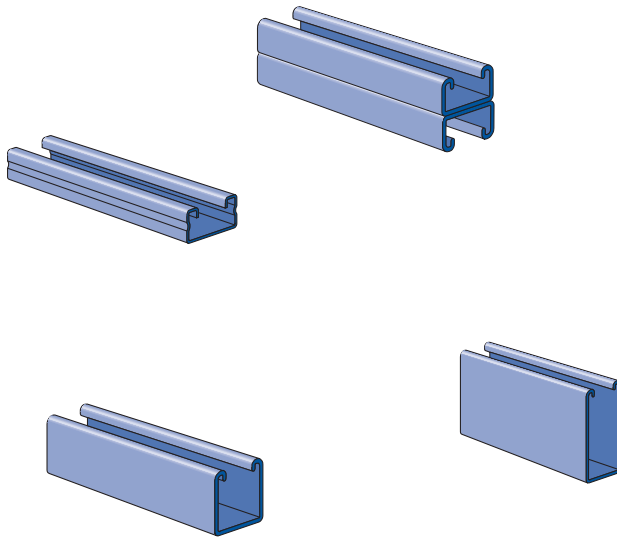

1 1/4" FRAMING SYSTEM



A1000 (14 Gauge)	169-170
A3300 (14 Gauge)	171-172
A4000 (19 Gauge)	173-174
A5000 (14 Gauge)	175
Channel Nuts and Closure Strips	176-177
Flat Plate Fittings	177
Ninety Degree Fittings.....	177-178
"Z" Shape Fittings	178
Angle and Wing Shape Fittings	179
"U" Shape Fittings	179
Tubing Clips	180
Brackets	180

MATERIAL

Unistrut channels are accurately and carefully cold formed to size from low-carbon strip steel.

STEEL: PLAIN

- 14 Gauge (1.9 mm), ASTM A1011 SS GR 33
- 19 Gauge (1.0 mm) ASTM A1008

STEEL: PRE-GALVANIZED

- 14 Gauge (1.9 mm) ASTM A653 GR 33,
- 19 Gauge (1.0 mm) ASTM A653 GR 33

Channel nuts are manufactured from mild steel bars conforming to ASTM A576, GR 1015, and are case hardened.

Fittings are made from hot rolled, pickled and oiled steel plate or strip and conform to ASTM A1011 SS GR 33.

Many framing channels are available in special metal on request. Consult factory for ordering information.

FINISHES

All channels and fittings are available in: Perma-Green III (GR), Pre-galvanized (PG), conforming to ASTM A653 GR 33 and plain (PL).

Nuts are available in plain or electro-galvanized (EG) finish. Fittings are available in Perma-Green III (GR) or plain (PL).

STANDARD LENGTHS

Standard lengths are 10 feet (3.05M) and 20 feet (6.10M). Tolerances are: +1/8" (3.2 mm) to +1/2" (12.7 mm) to allow for cutting. Special lengths are available for a small cutting charge with a tolerance of ±1/8" (3.2mm).

APPLICATION

A framing system designed for medium loads, the 1 1/4" series is especially suitable for use in the OEM, commercial and display markets. It maintains a lightness in scale and a clean line that makes it aesthetically pleasing as well as functional.

THREADS

All threads on the nuts and bolts are Unified and American coarse screw threads.

DESIGN BOLT TORQUE

BOLT SIZE	1/4"-20	5/16"-18	3/8"-16
Rec. Torque	6	11	19
Ft/Lbs (N•m)	(8)	(15)	(26)
Max Torque	7	15	25
Ft/Lbs (N•m)	(9)	(20)	(34)

DIMENSIONS

Imperial dimensions are illustrated in inches. Metric dimensions are shown in parenthesis or as noted. Unless noted, all metric dimensions are in millimeters and rounded to one decimal place.

LOAD DATA

All beam and column load data pertains to carbon steel and stainless steel channels. Load tables and charts are constructed to be in accordance with the SPECIFICATION FOR THE DESIGN OF COLD-FORMED STEEL STRUCTURAL MEMBERS 2007 EDITION published by the AMERICAN IRON AND STEEL INSTITUTE USING ASD METHOD. Loads are based on 33 ksi steel cold formed to 42 ksi.

Type of Load	Safety Factor to Yield Strength	Safety Factor to Ultimate Strength
Beam Loads	1.67	2.0
Column Load	1.80	2.2



1 1/2" System

A1000 Series

1 1/4" x 1 1/4"
14 Ga.

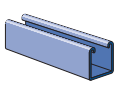

A1000-Pg 169

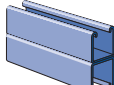

A1001-Pg 169

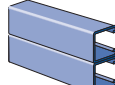

A1001 A-Pg 170

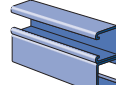

A1001 B-Pg 170

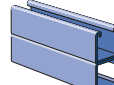

A1001 C-Pg 170

A3300 Series

1 1/4" x 3/4"
14 Ga.

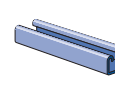

A3300-Pg 171

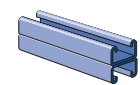

A3301-Pg 171

1 1/4" System

A4000 Series

1 1/4" x 5/8"
19 Ga.

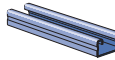

A4000-Pg 173

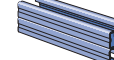

A4001-Pg 173

A5000 Series

1 1/4" x 2 1/2"
14 Ga.



A5000-Pg 175

Channel Nuts & Closures



A1006-1420-Pg 175



A4006-1420-Pg 176



A5006-1420-Pg 176

1 3/16" System

A3006-1420-Pg 176

A3016-0832-Pg 176

A1280-Pg 177

A4280-Pg 177

A5280-Pg 177

A1184-Pg 177

A1184P-Pg 177

Fiberglass System

A Series Fittings



A1063-Pg 177



A1065-Pg 177

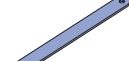

A1191-Pg 177



A1066-Pg 177



A2324-Pg 177



A1036-Pg 177

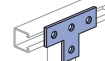

A1031-Pg 177



A1026-Pg 177

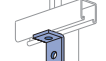

A1068-Pg 177

Special Metals

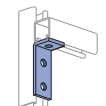

A1326-Pg 177

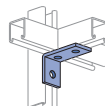

A1458-Pg 177

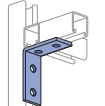

A1325-Pg 178

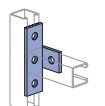

A1033-Pg 178

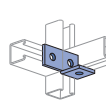

A1037-Pg 178

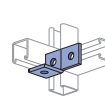

A1038-Pg 178

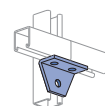

A1357-Pg 178

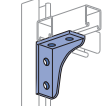

A1331-Pg 178

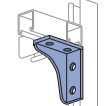

A1332-Pg 178

Prime Angle

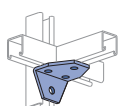

A1579-Pg 178

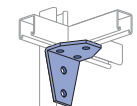

A2235-Pg 178

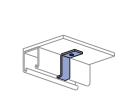

A2120-Pg 178

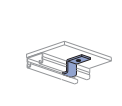

A4120-Pg 178

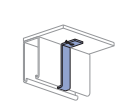

A5120-Pg 178

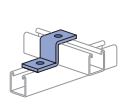

A1045-Pg 178

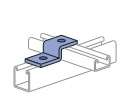

A3345-Pg 178

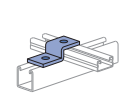

A4045-Pg 178

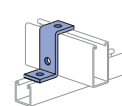

A5045-Pg 178

Metal Grating

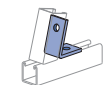

A2109-Pg 179

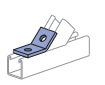

A2125-Pg 179

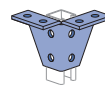

A2084-Pg 179

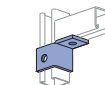

A2341 R-L-Pg 179

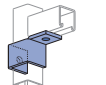

A2472 R-L-Pg 179

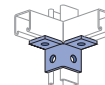

A2223-Pg 179

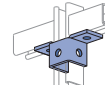

A2345-Pg 179

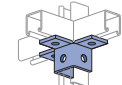

A2227-Pg 179

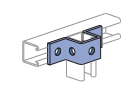

A1047-Pg 179

Roofwalk

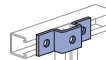

A3347-Pg 179

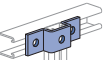

A4047-Pg 179

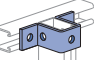

A5047-Pg 179

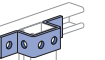

A5043-Pg 179



A2608-Pg 180

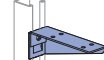

A2491 R-Pg 180

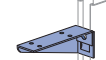

A2491 L-Pg 180

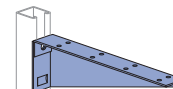

A2494 R-Pg 180

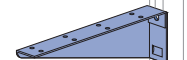

A2494 L-Pg 180

Index



1 1/2" System

1 1/4" System

1 3/16" System

Fiberglass System

Special Metals

Prime Angle

Metal Grating

Roofwalk

Index

A1000 - BEAM LOADING (METRIC)

Span mm	Max Allowable Uniform Load kN	Defl. at Uniform Load mm	Uniform Loading at Deflection		
			Span/180 kN	Span/240 kN	Span/360 kN
600	3.2	2	3.2	3.2	3.1
750	2.6	3	2.6	2.6	2.0
1,000	2.0	5	2.0	1.6	1.1
1,250	1.6	8	1.4	1.1	0.7
1,500	1.3	11	1.0	0.7	0.5
1,750	1.1	15	0.7	0.5	0.4
2,000	1.0	20	0.5	0.4	0.3
2,500	0.8	32	0.4	0.3	0.2
3,000	0.7	46	0.2	0.2	0.1

A1001 - BEAM LOADING (METRIC)

Span mm	Max Allowable Uniform Load kN	Defl. at Uniform Load mm	Uniform Loading at Deflection		
			Span/180 kN	Span/240 kN	Span/360 kN
600	7.3*	1	7.3*	7.3*	7.3
750	7.3*	2	7.3*	7.3*	7.3
1,000	5.5	3	5.5	5.5	5.5
1,250	4.4	4	4.4	4.4	3.5
1,500	3.6	6	3.6	3.6	2.4
1,750	3.2	9	3.2	2.7	1.8
2,000	2.8	11	2.7	2.0	1.4
2,500	2.2	17	1.7	1.3	0.9
3,000	1.8	25	1.2	0.9	0.6
3,500	1.6	34	0.9	0.7	0.4

A1000 - COLUMN LOADING (METRIC)

Unbraced Height mm	Maximum Allowable Load at Slot Face kN	Max. Column Load Applied at C.G.			
		K = 0.65 kN	K = 0.80 kN	K = 1.0 kN	K = 1.2 kN
600	8.2	23.4	20.7	17.3	14.6
750	7.5	20.5	17.3	14.0	11.3
1,000	6.3	16.2	13.0	9.9	8.1
1,250	5.3	12.8	9.9	7.7	6.3
1,500	4.6	10.2	8.1	6.3	5.2
1,750	4.1	8.6	6.8	5.3	4.3
2,000	3.6	7.4	5.9	4.5	**
2,250	3.3	6.5	5.2	3.9	**
2,500	3.0	5.8	4.5	**	**
2,750	2.7	5.2	4.0	**	**

A1001 - COLUMN LOADING (METRIC)

Unbraced Height mm	Maximum Allowable Load at Slot Face kN	Max. Column Load Applied at C.G.			
		K = 0.65 kN	K = 0.80 kN	K = 1.0 kN	K = 1.2 kN
600	15.5	56.9	54.5	51.6	48.9
750	15.2	54.4	51.6	48.4	45.7
1,000	14.9	50.4	47.4	43.9	37.4
1,250	14.4	47.2	43.9	35.7	27.8
1,500	13.3	44.6	37.4	27.8	19.6
1,750	12.1	39.4	30.9	20.7	14.4
2,000	10.8	34.1	24.8	15.9	11.0
2,250	9.5	29.0	19.6	12.5	**
2,500	8.4	24.1	15.9	10.2	**
2,750	7.4	19.9	13.1	**	**

Notes:

* Load limited by spot weld shear.

** KL/r > 200

NR = Not Recommended.

- Beam loads are given in total uniform load (W Lbs) not uniform load (w lbs/ft or w lbs/in).
- Beam loads are based on a simple span and assumed to be adequately laterally braced. Unbraced spans can reduce beam load carrying capacity. Refer to Page 176 for reduction factors for unbraced lengths.
- Deduct channel weight from the beam loads.
- For concentrated midspan point loads, multiply beam loads by 50% and the corresponding deflection by 80%. For other load conditions refer to page 18.
- All beam loads are for bending about Axis 1-1.

Finishes: PL, GR, HG, PG Standard Lengths: 10' & 20'

A1000/A1001 - ELEMENTS OF SECTION (METRIC)

Parameter	A1000		A1001	
Area of Section	1.96	cm ²	3.93	cm ²
Axis 1-1				
Moment of Inertia (I)	2.53	cm ⁴	12.57	cm ⁴
Section Modulus (S)	1.41	cm ³	3.96	cm ³
Radius of Gyration (r)	1.14	cm	1.79	cm
Axis 2-2				
Moment of Inertia (I)	3.25	cm ⁴	6.50	cm ⁴
Section Modulus (S)	2.05	cm ³	4.09	cm ³
Radius of Gyration (r)	1.29	cm	1.29	cm

A1001A - 1 1/4" x 2 1/2"

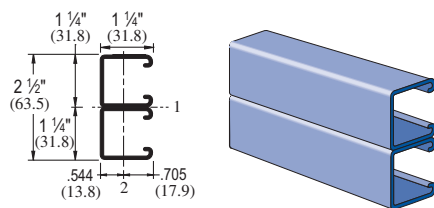

Wt/100 Ft: 207 Lbs (308 kg/100m)
 Allowable Moment 7,930 In-Lbs (900 N•m)
 14 Gauge Nominal Thickness .075" (1.9mm)

A1001B - 1 1/4" x 2 1/2"

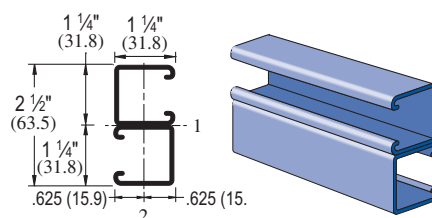

Wt/100 Ft: 207 Lbs (308 kg/100m)
 Allowable Moment 7,930 In-Lbs (900 N•m)
 14 Gauge Nominal Thickness .075" (1.9mm)

A1001C - 1 1/4" x 2 1/2"

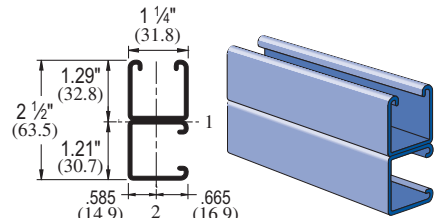

Wt/100 Ft: 207 Lbs (308 kg/100m)
 Allowable Moment 6,760 In-Lbs (760 N•m)
 14 Gauge Nominal Thickness .075" (1.9mm)

A3300 – 1 1/4" x 3/4"

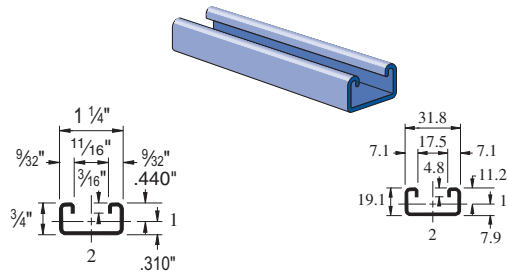

Wt/100 Ft: 78 Lbs (116 kg/100m)
 Allowable Moment 950 In-Lbs (110 N•m)
 14 Gauge Nominal Thickness .075" (1.9mm)

A3301 – 1 1/4" x 1 1/2"

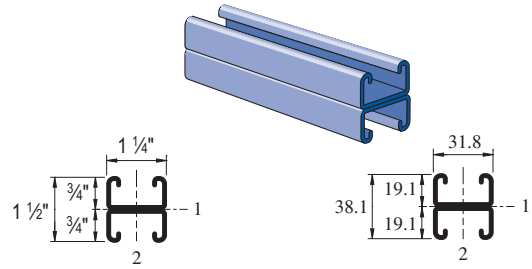

Wt/100 Ft: 156 Lbs (232 kg/100m)
 Allowable Moment 2,590 In-Lbs (290 N•m)
 14 Gauge Nominal Thickness .075" (1.9mm)

A3300 - BEAM LOADING

Span In	Max Allowable Uniform Load Lbs	Defl. at Uniform Load In	Uniform Loading at Deflection		
			Span/180 Lbs	Span/240 Lbs	Span/360 Lbs
18	420	0.07	420	420	320
24	320	0.12	320	270	180
36	210	0.26	160	120	80
48	160	0.47	90	70	50
60	130	0.75	60	40	30
72	110	1.09	40	30	20
84	90	1.42	30	20	10
96	80	1.88	20	20	10

A3301 - BEAM LOADING

Span In	Max Allowable Uniform Load Lbs	Defl. at Uniform Load In	Uniform Loading at Deflection		
			Span/180 Lbs	Span/240 Lbs	Span/360 Lbs
18	990*	0.03	990*	990*	990*
24	860	0.07	860	860	850
36	580	0.15	580	560	380
48	430	0.27	420	320	210
60	350	0.43	270	200	140
72	290	0.62	190	140	90
84	250	0.85	140	100	70
96	220	1.11	110	80	50

A3300 - COLUMN LOADING

Unbraced Height In	Maximum Allowable Load at Slot Face Lbs	Max. Column Load Applied at C.G.			
		K = 0.65 Lbs	K = 0.80 Lbs	K = 1.0 Lbs	K = 1.2 Lbs
18	1,430	4,490	4,210	3,860	3,550
24	1,370	4,090	3,750	3,310	2,680
36	1,190	3,390	2,680	1,820	1,260
48	900	2,380	1,600	1,020	**
60	680	1,550	1,020	**	**

A3301 - COLUMN LOADING

Unbraced Height In	Maximum Allowable Load at Slot Face Lbs	Max. Column Load Applied at C.G.			
		K = 0.65 Lbs	K = 0.80 Lbs	K = 1.0 Lbs	K = 1.2 Lbs
18	2,540	9,890	9,620	9,300	9,020
24	2,510	9,510	9,200	8,710	7,960
36	2,410	8,800	7,960	6,730	5,490
48	2,230	7,560	6,320	4,690	3,310
60	1,970	6,210	4,690	3,050	2,120
72	1,650	4,890	3,310	2,120	**
84	1,380	3,680	2,430	**	**
96	1,160	2,820	1,860	**	**

A3300/A3301 - ELEMENTS OF SECTION

Parameter	A3300	A3301
Area of Section	0.230 In ²	0.459 In ²
Axis 1-1		
Moment of Inertia (I)	0.017 In ⁴	0.077 In ⁴
Section Modulus (S)	0.038 In ³	0.103 In ³
Radius of Gyration (r)	0.269 In	0.411 In
Axis 2-2		
Moment of Inertia (I)	0.052 In ⁴	0.104 In ⁴
Section Modulus (S)	0.083 In ³	0.167 In ³
Radius of Gyration (r)	0.477 In	0.477 In

Notes:

* Load limited by spot weld shear.

** KL/r > 200

NR = Not Recommended.

1. Beam loads are given in total uniform load (W Lbs) not uniform load (w lbs/ft or w lbs/in).
2. Beam loads are based on a simple span and assumed to be adequately laterally braced. Unbraced spans can reduce beam load carrying capacity. Refer to Page 176 for reduction factors for unbraced lengths.
3. Deduct channel weight from the beam loads.
4. For concentrated midspan point loads, multiply beam loads by 50% and the corresponding deflection by 80%. For other load conditions refer to page 18.
5. All beam loads are for bending about Axis 1-1.

1 1/2" System
 1 1/4" System
 1 3/16" System
 Fiberglass System
 Special Metals
 Prime Angle
 Metal Grating
 Roofwalk
 Index

A3300 - BEAM LOADING (METRIC)

Span mm	Max Allowable Uniform Load kN	Defl. at Uniform Load mm	Uniform Loading at Deflection		
			Span/180 kN	Span/240 kN	Span/360 kN
600	1.4	3	1.4	1.2	0.8
750	1.2	5	1.1	0.8	0.5
1,000	0.8	8	0.6	0.4	0.3
1,250	0.7	12	0.4	0.3	0.2
1,500	0.6	18	0.3	0.2	0.1
1,750	0.5	24	0.2	0.1	0.1
2,000	0.4	33	0.1	0.1	0.1

A3301 - BEAM LOADING (METRIC)

Span mm	Max Allowable Uniform Load kN	Defl. at Uniform Load mm	Uniform Loading at Deflection		
			Span/180 kN	Span/240 kN	Span/360 kN
600	3.9	2	3.9	3.9	3.9
750	3.1	3	3.1	3.1	2.5
1,000	2.4	5	2.4	2.1	1.4
1,250	1.9	7	1.8	1.3	0.9
1,500	1.6	10	1.2	0.9	0.6
1,750	1.3	14	0.9	0.7	0.4
2,000	1.2	18	0.7	0.5	0.4
2,500	0.9	29	0.4	0.4	0.2
3,000	0.8	43	0.3	0.2	0.1

A3300 - COLUMN LOADING (METRIC)

Unbraced Height mm	Maximum Allowable Load at Slot Face kN	Max. Column Load Applied at C.G.			
		K = 0.65 kN	K = 0.80 kN	K = 1.0 kN	K = 1.2 kN
600	6.1	18.3	16.8	14.9	12.2
750	5.8	16.7	14.9	11.5	8.4
1,000	4.9	13.8	10.4	6.8	4.7
1,250	3.9	10.1	6.8	4.3	**
1,500	3.1	7.1	4.7	**	**

A3301 - COLUMN LOADING (METRIC)

Unbraced Height mm	Maximum Allowable Load at Slot Face kN	Max. Column Load Applied at C.G.			
		K = 0.65 kN	K = 0.80 kN	K = 1.0 kN	K = 1.2 kN
600	11.2	42.4	41.0	39.0	35.7
750	11.0	40.9	39.0	34.9	30.4
1,000	10.5	37.7	33.4	27.4	21.4
1,250	9.8	33.0	27.4	20.0	14.0
1,500	8.9	28.1	21.4	14.0	9.7
1,750	7.7	23.2	16.1	10.3	**
2,000	6.7	18.6	12.3	7.9	**
2,250	5.8	14.7	9.7	**	**
2,500	5.0	11.9	7.9	**	**

Notes:

* Load limited by spot weld shear.

** $KL/r > 200$

NR = Not Recommended.

1. Beam loads are given in total uniform load (W Lbs) not uniform load (w lbs/ft or w lbs/in).
2. Beam loads are based on a simple span and assumed to be adequately laterally braced. Unbraced spans can reduce beam load carrying capacity. Refer to Page 176 for reduction factors for unbraced lengths.
3. Deduct channel weight from the beam loads.
4. For concentrated midspan point loads, multiply beam loads by 50% and the corresponding deflection by 80%. For other load conditions refer to page 18.
5. All beam loads are for bending about Axis 1-1.

A3300/A3301 - ELEMENTS OF SECTION (METRIC)

Parameter	A3300		A3301	
Area of Section	1.48	cm ²	2.96	cm ²
Axis 1-1				
Moment of Inertia (I)	0.69	cm ⁴	3.22	cm ⁴
Section Modulus (S)	0.62	cm ³	1.69	cm ³
Radius of Gyration (r)	0.68	cm	1.04	cm
Axis 2-2				
Moment of Inertia (I)	2.17	cm ⁴	4.34	cm ⁴
Section Modulus (S)	1.37	cm ³	2.73	cm ³
Radius of Gyration (r)	1.21	cm	1.21	cm

A4000 – 1 1/4" x 5/8"

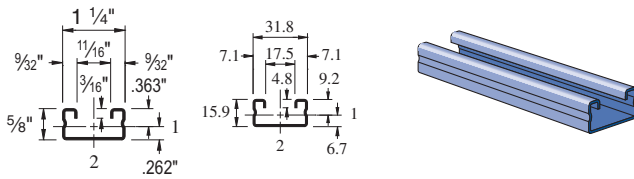

Wt/100 Ft: 45 Lbs (67 kg/100m)
 Allowable Moment 560 In-Lbs (60 N•m)
 19 Gauge Nominal Thickness .040" (1.0mm)

A4001– 1 1/4" x 1 1/4"

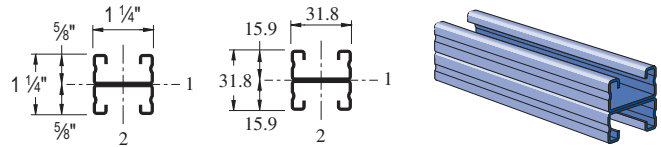

Wt/100 Ft: 90 Lbs (134 kg/100m)
 Allowable Moment 1,470 In-Lbs (170 N•m)
 19 Gauge Nominal Thickness .040" (1.0mm)

A4000 - BEAM LOADING

Span In	Max Allowable Uniform Load Lbs	Defl. at Uniform Load In	Uniform Loading at Deflection		
			Span/180 Lbs	Span/240 Lbs	Span/360 Lbs
18	250	0.08	250	220	150
24	190	0.15	170	120	80
36	120	0.32	70	60	40
48	90	0.58	40	30	20
60	70	0.88	30	20	10
72	60	1.30	20	10	10

A4001 - BEAM LOADING

Span In	Max Allowable Uniform Load Lbs	Defl. at Uniform Load In	Uniform Loading at Deflection		
			Span/180 Lbs	Span/240 Lbs	Span/360 Lbs
18	350*	0.02	350*	350*	350*
24	350*	0.06	350*	350*	350*
36	330	0.19	330	270	180
48	240	0.32	200	150	100
60	200	0.52	130	100	60
72	160	0.72	90	70	40
84	140	1.00	70	50	30

A4000 - COLUMN LOADING

Unbraced Height In	Maximum Allowable Load at Slot Face Lbs	Max. Column Load Applied at C.G.			
		K = 0.65 Lbs	K = 0.80 Lbs	K = 1.0 Lbs	K = 1.2 Lbs
18	960	2,510	2,290	1,990	1,700
24	880	2,190	1,890	1,530	1,230
36	670	1,570	1,230	830	580
48	470	1,110	730	470	**
60	340	710	470	**	**

A4001 - COLUMN LOADING

Unbraced Height In	Maximum Allowable Load at Slot Face Lbs	Max. Column Load Applied at C.G.			
		K = 0.65 Lbs	K = 0.80 Lbs	K = 1.0 Lbs	K = 1.2 Lbs
18	1,640	5,640	5,420	5,110	4,800
24	1,600	5,320	5,000	4,600	4,240
36	1,510	4,650	4,240	3,500	2,730
48	1,330	4,030	3,240	2,250	1,560
60	1,090	3,170	2,250	1,440	1,000
72	870	2,370	1,560	1,000	**
84	700	1,740	1,150	**	**

A4000/A4001 - ELEMENTS OF SECTION

Parameter	A4000	A4001
Area of Section	0.132 In ²	0.264 In ²
Axis 1-1		
Moment of Inertia (I)	0.008 In ⁴	0.037 In ⁴
Section Modulus (S)	0.022 In ³	0.058 In ³
Radius of Gyration (r)	0.240 In	0.372 In
Axis 2-2		
Moment of Inertia (I)	0.029 In ⁴	0.058 In ⁴
Section Modulus (S)	0.046 In ³	0.093 In ³
Radius of Gyration (r)	0.469 In	0.469 In

Notes:

* Load limited by spot weld shear.

** KL/r > 200

NR = Not Recommended.

1. Beam loads are given in total uniform load (W Lbs) not uniform load (w lbs/ft or w lbs/in).
2. Beam loads are based on a simple span and assumed to be adequately laterally braced. Unbraced spans can reduce beam load carrying capacity. Refer to Page 176 for reduction factors for unbraced lengths.
3. Deduct channel weight from the beam loads.
4. For concentrated midspan point loads, multiply beam loads by 50% and the corresponding deflection by 80%. For other load conditions refer to page 18.
5. All beam loads are for bending about Axis 1-1.

1 1/2" System

1 1/4" System

1 3/16" System

Fiberglass System

Special Metals

Prime Angle

Metal Grating

Roofwalk

Index

A4000 - BEAM LOADING (METRIC)

Span mm	Max Allowable Uniform Load kN	Defl. at Uniform Load mm	Uniform Loading at Deflection		
			Span/180 kN	Span/240 kN	Span/360 kN
600	0.8	4	0.8	0.6	0.4
750	0.7	6	0.5	0.4	0.3
1,000	0.5	10	0.3	0.2	0.1
1,250	0.4	16	0.2	0.1	0.1
1,500	0.4	24	0.1	0.1	0.0

A4001 - BEAM LOADING (METRIC)

Span mm	Max Allowable Uniform Load kN	Defl. at Uniform Load mm	Uniform Loading at Deflection		
			Span/180 kN	Span/240 kN	Span/360 kN
600	1.6*	1	1.6*	1.6*	1.6
750	1.6*	3	1.6*	1.6*	1.2
1,000	1.3	6	1.3	1.0	0.7
1,250	1.1	9	0.8	0.6	0.4
1,500	0.9	13	0.6	0.4	0.3
1,750	0.8	17	0.4	0.3	0.2
2,000	0.7	22	0.3	0.3	0.2

A4000 - COLUMN LOADING (METRIC)

Unbraced Height mm	Maximum Allowable Load at Slot Face kN	Max. Column Load Applied at C.G.			
		K = 0.65 kN	K = 0.80 kN	K = 1.0 kN	K = 1.2 kN
600	3.9	9.8	8.5	6.9	5.6
750	3.5	8.4	6.9	5.3	3.8
1,000	2.8	6.4	4.8	3.1	2.1
1,250	2.0	4.7	3.1	**	**
1,500	1.5	3.2	2.1	**	**

A4001 - COLUMN LOADING (METRIC)

Unbraced Height mm	Maximum Allowable Load at Slot Face kN	Max. Column Load Applied at C.G.			
		K = 0.65 kN	K = 0.80 kN	K = 1.0 kN	K = 1.2 kN
600	7.1	23.8	22.4	20.6	19.0
750	6.9	22.3	20.6	18.6	15.8
1,000	6.6	19.9	17.8	13.9	10.3
1,250	5.8	17.5	13.9	9.5	6.6
1,500	4.9	14.4	10.3	6.6	4.6
1,750	4.1	11.4	7.6	4.8	**
2,000	3.4	8.8	5.8	**	**
2,250	2.9	6.9	4.6	**	**

A4000/A4001 - ELEMENTS OF SECTION (METRIC)

Parameter	A4000		A4001	
Area of Section	0.85	cm ²	1.70	cm ²
Axis 1-1				
Moment of Inertia (I)	0.32	cm ⁴	1.52	cm ⁴
Section Modulus (S)	0.37	cm ³	0.96	cm ³
Radius of Gyration (r)	0.61	cm	0.94	cm
Axis 2-2				
Moment of Inertia (I)	1.21	cm ⁴	2.42	cm ⁴
Section Modulus (S)	0.76	cm ³	1.52	cm ³
Radius of Gyration (r)	1.19	cm	1.19	cm

Notes:

* Load limited by spot weld shear.

** KL/r > 200

NR = Not Recommended.

1. Beam loads are given in total uniform load (W Lbs) not uniform load (w lbs/ft or w lbs/in).
2. Beam loads are based on a simple span and assumed to be adequately laterally braced. Unbraced spans can reduce beam load carrying capacity. Refer to Page 176 for reduction factors for unbraced lengths.
3. Deduct channel weight from the beam loads.
4. For concentrated midspan point loads, multiply beam loads by 50% and the corresponding deflection by 80%. For other load conditions refer to page 18.
5. All beam loads are for bending about Axis 1-1.

A5000 – 1¼" x 2½"

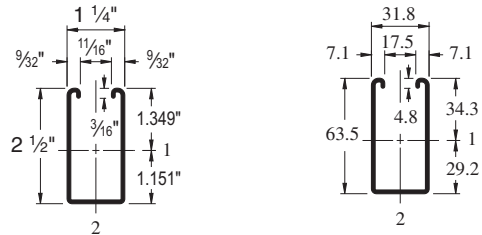
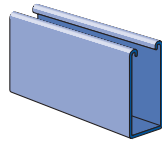

Wt/100 Ft: 167 Lbs (249 kg/100m)
 Allowable Moment 6,670 In-Lbs (750 N•m)
 14 Gauge Nominal Thickness .075" (1.9mm)

A5000 - BEAM LOADING

Span In	Max Allowable Uniform Load Lbs	Defl. at Uniform Load Lbs	Uniform Loading at Deflection		
			Span/180 Lbs	Span/240 Lbs	Span/360 Lbs
24	2,220	0.04	2,220	2,220	2,220
36	1,480	0.09	1,480	1,480	1,480
48	1,110	0.15	1,110	1,110	980
60	890	0.24	890	890	630
72	740	0.34	740	650	430
84	640	0.47	640	480	320
96	560	0.61	490	370	240
108	490	0.76	390	290	190
120	440	0.94	310	230	160

A5000 - BEAM LOADING (METRIC)

Span mm	Max Allowable Uniform Load kN	Defl. at Uniform Load mm	Uniform Loading at Deflection		
			Span/180 kN	Span/240 kN	Span/360 kN
600	10.1	1	10.1	10.1	10.1
750	8.1	1	8.1	8.1	8.1
1,000	6.1	3	6.1	6.1	6.1
1,250	4.8	4	4.8	4.8	4.1
1,500	4.0	6	4.0	4.0	2.9
1,750	3.4	8	3.4	3.2	2.1
2,000	3.0	10	3.0	2.4	1.6
2,500	2.4	16	2.1	1.6	1.0
3,000	2.0	23	1.4	1.1	0.7

A5000 - COLUMN LOADING

Unbraced Height In	Maximum Allowable Load at Slot Face Lbs	Max. Column Load Applied at C.G.			
		K = 0.65 Lbs	K = 0.80 Lbs	K = 1.0 Lbs	K = 1.2 Lbs
24	2,790	7,950	6,670	5,080	3,760
36	1,950	5,270	3,760	2,600	1,970
48	1,360	3,290	2,350	1,690	1,330
60	990	2,300	1,690	1,260	1,010
72	790	1,750	1,330	1,010	830
84	660	1,420	1,100	860	710
96	570	1,200	940	740	**
108	510	1,040	830	**	**
120	460	930	740	**	**

A5000 - COLUMN LOADING (METRIC)

Unbraced Height mm	Maximum Allowable Load at Slot Face kN	Max. Column Load Applied at C.G.			
		K = 0.65 kN	K = 0.80 kN	K = 1.0 kN	K = 1.2 kN
600	12.5	35.8	30.2	23.1	17.2
750	10.7	29.7	23.1	16.0	11.9
1,000	7.8	20.5	14.4	10.1	7.7
1,250	5.8	14.0	10.1	7.3	5.7
1,500	4.5	10.5	7.7	5.7	4.6
1,750	3.7	8.3	6.2	4.8	3.9
2,000	3.2	6.9	5.3	4.1	3.3
2,250	2.8	5.9	4.6	3.6	3.0
2,500	2.5	5.2	4.1	3.2	**

A5000 - ELEMENTS OF SECTION

Parameter	A5000	
Area of Section	0.492	In ²
Axis 1-1		
Moment of Inertia (I)	0.358	In ⁴
Section Modulus (S)	0.265	In ³
Radius of Gyration (r)	0.853	In
Axis 2-2		
Moment of Inertia (I)	0.143	In ⁴
Section Modulus (S)	0.229	In ³
Radius of Gyration (r)	0.539	In

A5000 - ELEMENTS OF SECTION (METRIC)

Parameter	A5000	
Area of Section	3.17	cm ²
Axis 1-1		
Moment of Inertia (I)	14.91	cm ⁴
Section Modulus (S)	4.35	cm ³
Radius of Gyration (r)	2.17	cm
Axis 2-2		
Moment of Inertia (I)	5.94	cm ⁴
Section Modulus (S)	3.74	cm ³
Radius of Gyration (r)	1.37	cm

Notes:

* Load limited by spot weld shear.

** KL/r > 200

NR = Not Recommended.

1. Beam loads are given in total uniform load (W Lbs) not uniform load (w lbs/ft or w lbs/in).
2. Beam loads are based on a simple span and assumed to be adequately laterally braced. Unbraced spans can reduce beam load carrying capacity. Refer to Page 176 for reduction factors for unbraced lengths.
3. Deduct channel weight from the beam loads.
4. For concentrated midspan point loads, multiply beam loads by 50% & the corresponding deflection by 80%. Other load conditions refer to page 18.
5. All beam loads are for bending about Axis 1-1.



BEARING LOADS ON UNISTRUT CHANNEL

Loads are calculated based on 2001 Specification For The Design Of Cold Formed Steel Structural Members published by AISI				
	Channel	Bearing Length 1¼" (31.8 mm) Maximum Allowable Loads - Lbs (kN)	Bearing Length 1¼" (31.8 mm) Maximum Allowable Loads - Lbs (kN)	Bearing Length 2½" (63.5 mm) Maximum Allowable Loads - Lbs (kN)
	A1000	3,700 (16.46)	1,700 (7.56)	4,300 (19.13)
	A3300	3,800 (16.90)	1,700 (7.56)	4,300 (19.13)
	A4000	1,200 (5.34)	600 (2.67)	1,400 (6.23)
A5000	3,600 (16.01)	1,600 (7.12)	4,200 (18.68)	

MAXIMUM ALLOWABLE PULL-OUT AND SLIP LOADS

Nut Size/ Thread	Channel	Gauge	Max Allowable Pull-Out Lbs (kN)	Resistance to Slip Lbs (kN)	Torque Ft-Lbs (N·m)
¾" -16	A1000	14	900	500	19
			4.00	2.22	26
⅝" -18	A3300	14	900	500	11
			4.00	2.22	15
¼" -20	A5000	14	900	500	6
			4.00	2.22	8
⅜" -16	A4000	19	300	400	19
			1.33	1.78	26

Nut design loads include a minimum safety factor of 3.

LATERAL BRACING LOAD REDUCTION CHARTS

Span		Single Channel				Double Channel		
Ft. (m)	In. (cm)	A1000	A3300	A4000	A5000	A1001	A3301	A4001
2 (0.6)	24 (61)	0.95	1.00	0.94	0.90	1.00	1.00	1.00
3 (0.9)	36 (91)	0.86	0.97	0.83	0.69	1.00	1.00	0.97
4 (1.2)	48 (122)	0.78	0.94	0.73	0.49	0.95	0.99	0.89
5 (1.5)	60 (152)	0.72	0.91	0.65	0.37	0.90	0.95	0.82
6 (1.8)	72 (183)	0.67	0.89	0.58	0.31	0.84	0.91	0.74
7 (2.1)	84 (213)	0.63	0.87	0.53	0.27	0.79	0.88	0.67
8 (2.4)	96 (244)	0.59	0.85	0.49	0.24	0.74	0.84	0.59
9 (2.7)	108 (274)	0.55	0.83	0.45	0.22	0.69	0.81	0.52
10 (3.1)	120 (305)	0.52	0.80	0.42	0.21	0.64	0.77	0.46
12 (3.7)	144 (366)	0.46	0.76	0.38	0.19	0.54	0.70	0.38

CHANNEL NUT WITH SPRING

	Part Number	Nut Size Thread	Wt/100 pcs Lbs (kg)	Use With
	A1006-1420	¼" -20	6 (2.7)	A1000
	A1007	⅝" -18	6 (2.7)	
	A1008	¾" -16	6 (2.7)	
	Part Number	Nut Size Thread	Wt/100 pcs Lbs (kg)	Use With
	A4006-1420	¼" -20	5 (2.3)	A3300, A4000
	A4007	⅝" -18	5 (2.3)	
	A4008	¾" -16	5 (2.3)	
	Part Number	Nut Size Thread	Wt/100 pcs Lbs (kg)	Use With
	A5006-1420	¼" -20	6 (2.7)	A5000
	A5007	⅝" -18	6 (2.7)	
	A5008	¾" -16	6 (2.7)	

CHANNEL NUT WITHOUT SPRINGS

	Part Number	Nut Size Thread	Wt/100 pcs Lbs (kg)	Use With
	A3006-1420	¼" -20	5 (2.3)	A1000, A3300, A4000, & A5000
	A3007	⅝" -18	5 (2.3)	
	A3008	¾" -16	5 (2.3)	
	Part Number	Nut Size Thread	Wt/100 pcs Lbs (kg)	Use With
	A3016-0832	#8 -32	1 (0.5)	A1000, A3300, A4000, & A5000
	A3016-1024	#10 -24	1 (0.5)	
	A3016-1032	#10 -32	1 (0.5)	
	A3016-1420	¼" -20	1 (0.5)	

A1280 END CAP

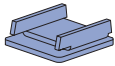

Material: .075" (1.9)
Note: Use with A1000 channel

Wt/100 pcs: 7 Lbs (3.2 kg)

A4280 END CAP



Material: .075" (1.9)
Note: Use with A4000 channel.

Wt/100 pcs: 3 Lbs (1.4 kg)

A5280 END CAP

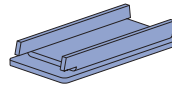

Material: .075" (1.9)
Note: Use with A5000 channel.

Wt/100 pcs: 14 Lbs (6.4 kg)

A1184 CLOSURE STRIP

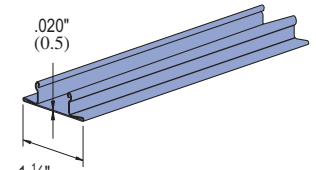

Standard Length 10 Feet
Finish:
Perma-Green II (GR), Plain (PL).

Wt/100 Ft: 21 Lbs (31.3 kg/100M)

A1191

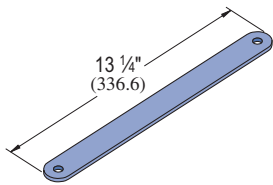

Wt/100 pcs: 87 Lbs (39.5 kg)

A1066

A1063

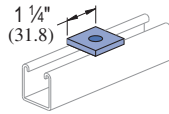

Wt/100 pcs: 8 Lbs (3.6 kg)

A2324

A1065

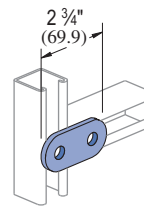

Wt/100 pcs: 17 Lbs (7.7 kg)

A1036

A1184P CLOSURE STRIP

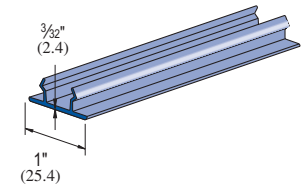

Standard length: 10 Ft.

Material: Paintable PVC.
Color: Green, Grey.

Wt/100 Ft: 21 Lbs (31.3 kg/100M)

A1031

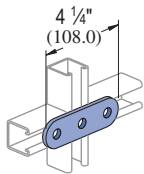

Wt/100 pcs: 26 Lbs (11.8 kg)

A1026

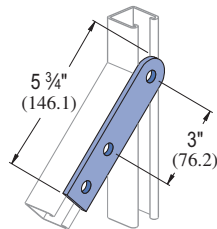

Wt/100 pcs: 39 Lbs (17.7 kg)

A1068

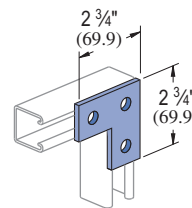

Wt/100 pcs: 27 Lbs (12.2 kg)

A1326

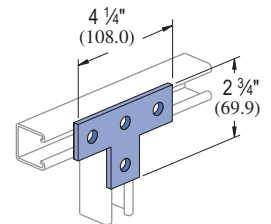

Wt/100 pcs: 34 Lbs (15.4 kg)

A1458

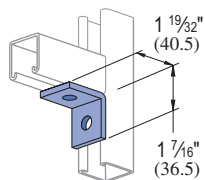

Wt/100 pcs: 17 Lbs (7.7 kg)

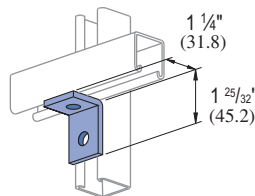

Wt/100 pcs: 17 Lbs (7.7 kg)

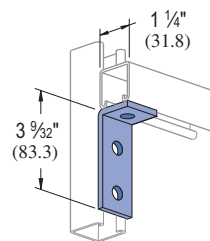

Wt/100 pcs: 27 Lbs (12.2 kg)

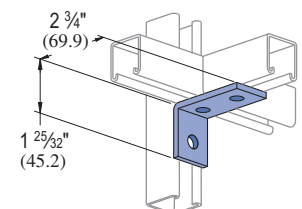

Wt/100 pcs: 27 Lbs (12.2 kg)

Standard Dimensions for 1/4" (32 mm) width series channel fittings (Unless Otherwise Shown on Drawing)

Hole Diameter: 13/32" (10mm); Hole Spacing - From End: 5/8" (16 mm); Hole Spacing - On Center: 1 1/2" (38mm); Width: 1 1/4" (32mm); Thickness: 3/16" (5mm)



1 1/2" System

1 1/4" System

1 3/16" System

Fiberglass System

Special Metals

Prime Angle

Metal Grating

Roofwalk

Index

A1325

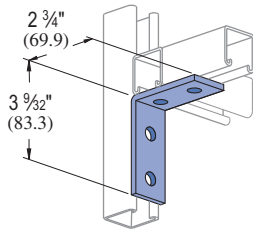

Wt/100 pcs: 38 Lbs (17.2 kg)

A1033

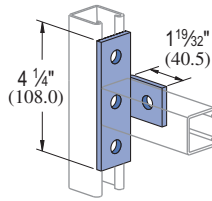

Wt/100 pcs: 34 Lbs (15.4 kg)

A1037

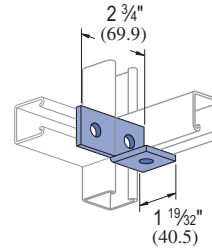

Wt/100 pcs: 30 Lbs (13.6 kg)

A1038

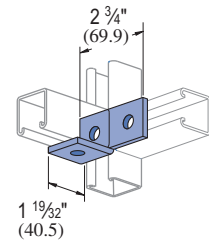

Wt/100 pcs: 30 Lbs (13.6 kg)

A1357

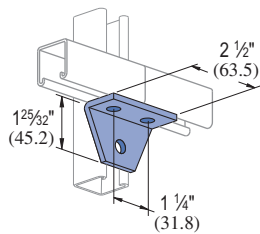

Wt/100 pcs: 30 Lbs (13.6 kg)

A1331

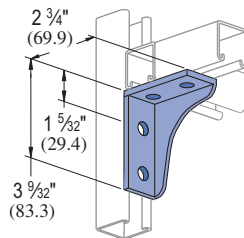

Wt/100 pcs: 75 Lbs (34.0 kg)

A1332

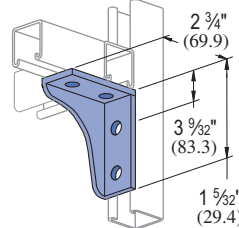

Wt/100 pcs: 75 Lbs (34.0 kg)

A1579

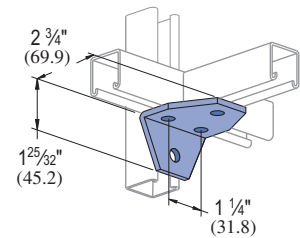

Wt/100 pcs: 44 Lbs (20.0 kg)

A2235

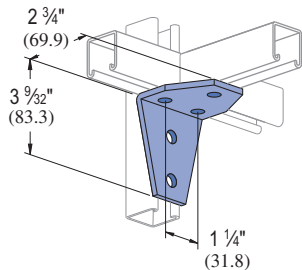

Wt/100 pcs: 59 Lbs (26.8 kg)

A2120

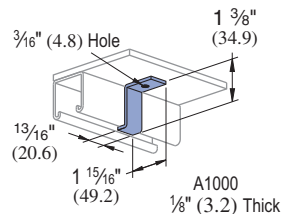

Wt/100 pcs: 9 Lbs (4.1 kg)

A4120

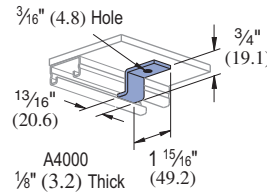

Wt/100 pcs: 7 Lbs (3.2 kg)

A5120

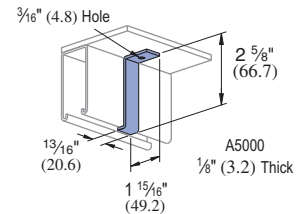

Wt/100 pcs: 13 Lbs (5.9 kg)

A1045

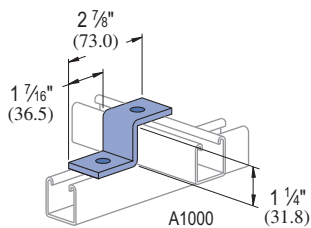

Wt/100 pcs: 25 Lbs (11.3 kg)

A3345

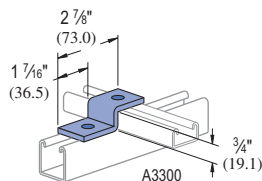

Wt/100 pcs: 23 Lbs (10.4 kg)

A4045

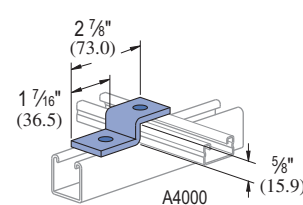

Wt/100 pcs: 21 Lbs (9.5 kg)

A5045

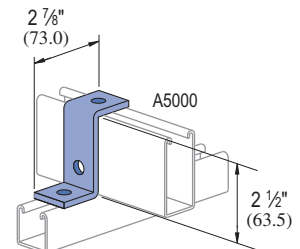

Wt/100 pcs: 33 Lbs (15.0 kg)

Standard Dimensions for 1 1/4" (32 mm) width series channel fittings (Unless Otherwise Shown on Drawing)

Hole Diameter: 13/32" (10mm); Hole Spacing - From End: 5/8" (16 mm); Hole Spacing - On Center: 1 1/2" (38= mm); Width: 1 1/4" (32mm); Thickness: 3/16" (5mm)

A2109, A2110, A2111

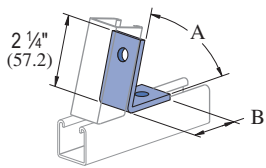

Part Number	A Degree (rad)	B In (mm)
A2109	52½° 0.92	1 ²⁵ / ₃₂ 45.2
A2110	45° 0.79	1¼ 44.5
A2111	37½° 0.65	1¼ 44.5

Wt/100 pcs: 23 Lbs (10.4 kg)

A2125, A2126, A2127

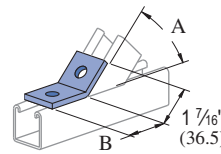

Part Number	A Degree (rad)	B In (mm)
A2125	52½° 0.92	1¼ 31.8
A2126	45° 0.79	1¼ 31.8
A2127	37½° 0.65	1 ¹ / ₃₂ 32.5

Wt/100 pcs: 17 Lbs (7.7 kg)

A2084

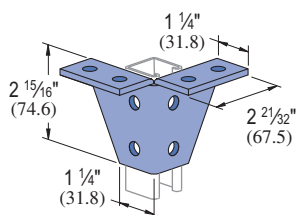

Wt/100 pcs: 90 Lbs (40.8 kg)

A2341 R-L

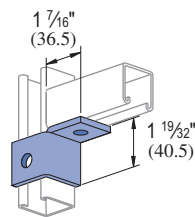

R-As shown
L-Opposite hand

Wt/100 pcs: 26 Lbs (11.8 kg)

A2472 R-L

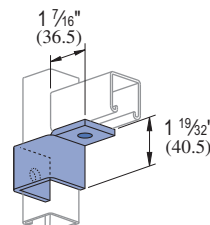

R-As shown
L-Opposite hand

Wt/100 pcs: 33 Lbs (15.0 kg)

A2223

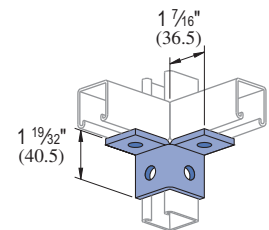

Wt/100 pcs: 34 Lbs (15.4 kg)

A2345

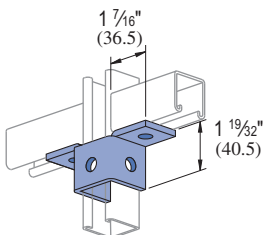

Wt/100 pcs: 41 Lbs (18.6 kg)

A2227

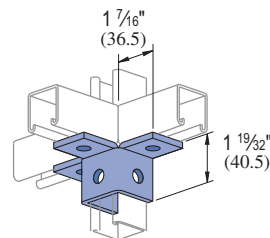

Wt/100 pcs: 52 Lbs (23.6 kg)

A1047

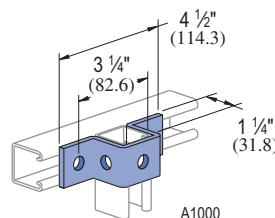

Wt/100 pcs: 43 Lbs (19.5 kg)

A3347

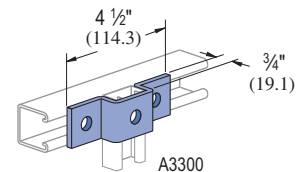

Wt/100 pcs: 37 Lbs (16.8 kg)

A4047

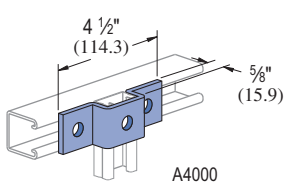

Wt/100 pcs: 34 Lbs (15.4 kg)

A5047

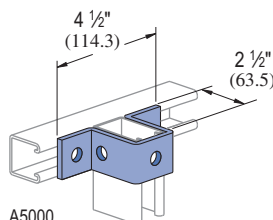

Wt/100 pcs: 58 Lbs (26.3 kg)

A5043

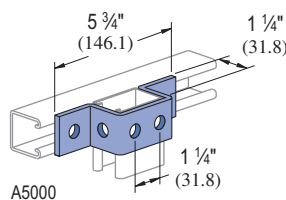

Wt/100 pcs: 50 Lbs (22.7 kg)

Standard Dimensions for 1¼" (32 mm) width series channel fittings (Unless Otherwise Shown on Drawing)

Hole Diameter: 1³/₃₂" (10mm); Hole Spacing - From End: 5⁄8" (16 mm); Hole Spacing - On Center: 1½" (38mm); Width: 1¼" (32mm); Thickness: 3⁄16" (5mm)



A2608 THRU A2617

UNI-CLIP®

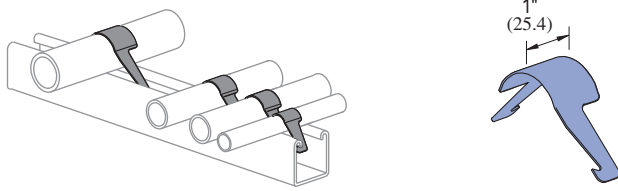

Part Number	Pipe Size In (mm)	O.D. Size In (mm)	Wt/100 pcs Lbs (kg)
A2608	¼ 6.4	0.540 13.7	0.6 0.3
A2609	⅜ 9.5	0.675 17.1	0.7 0.3
A2611	½ 12.7	0.840 21.3	1.0 0.5
A2612	¾ 19.1	1.050 26.7	1.4 0.6
A2613	1 25.4	1.315 33.4	2.0 0.9
A2614	1¼ 31.8	1.660 42.2	2.4 1.1
A2615	1½ 38.1	1.900 48.3	3.2 1.5
A2617	2 50.8	2.375 60.3	4.7 2.1

Stainless steel, Type 301.

A2491 R-L, A2492 R-L, A2493 R-L

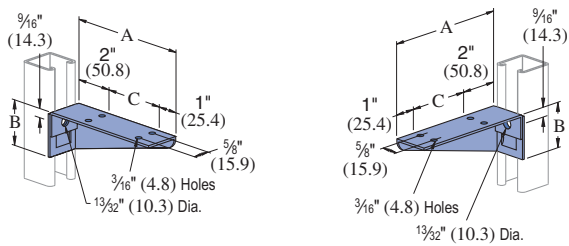

Right

Left

Part Number	A In (mm)	B In (mm)	C In (mm)	Wt/100 pcs Lbs (kg)
A2491 R-L	6 152.4	2 50.8	3 76.2	38 17.2
A2492 R-L	8 203.2	2½ 63.5	5 127.0	56 25.4
A2493 R-L	10 254.0	3 76.2	7 177.8	73 33.1

Design Uniform Load
(Channel Upright Listed)

A1000 200 Lbs (.89 kN)
A4000 130 Lbs (.58 kN)

Safety Factor of 2½

Material: 14 Gauge Steel.

A2494 R-L THRU A2497 R-L

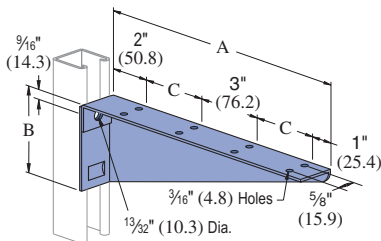

Right

Design Uniform Load
(Channel Upright Listed)
A1000 200 Lbs (.89 kN)
A4000 130 Lbs (.58 kN)
Safety Factor of 2½

Part Number	A In (mm)	B In (mm)	C In (mm)	Wt/100 pcs Lbs (kg)
A2494 R-L	12 304.8	3½ 88.9	3 76.2	94 42.6
A2495 R-L	14 355.6	4 101.6	4 101.6	105 47.6
A2496 R-L	16 406.4	4½ 114.3	5 127.0	145 65.8
A2497 R-L	18 457.2	5 127.0	6 152.4	175 79.4

Left

Material: 14 Gauge Steel.

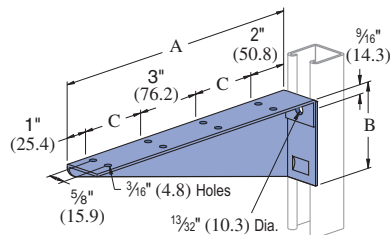

Standard Dimensions for 1¼" (32 mm) width series channel fittings (Unless Otherwise Shown on Drawing)

Hole Diameter: 13/32" (10mm); Hole Spacing - From End: 5/8" (16 mm); Hole Spacing - On Center: 1½" (38 mm); Width: 1¼"(32mm); Thickness: 3/16" (5mm)